

Držadla zapuštěná Typ: 291-037-AxB(s)
Materiál: PS; Barva: černá

A	B	s	a	b	a1	b1	H	h
126.0	24.0	1.2	117.0	13.0	120.0	17.0	12.5	2.5

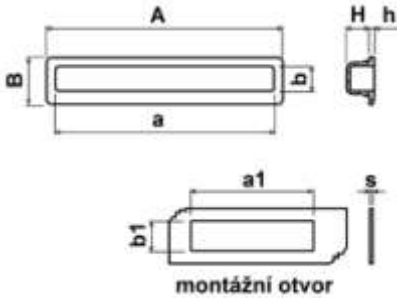

Držadla zapuštěná Typ: 291-183-AxB(s)
Materiál: ABS; Barva: černá, bílá, šedá, stříbrná

A	B	s	a	b	a1	b1	H	h
120.0	45.0	0.8	107.0	16.5	112.0	38.0	12.0	9.0
240.0	45.0	0.8	222.0	16.5	233.0	38.0	12.0	9.0

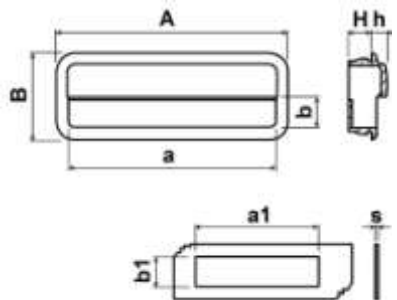

Držadla zapuštěná Typ: 291a-183-AxB(s)
Materiál: PS; Barva: černá, bílá, šedá, stříbrná

A	B	s	a	b	a1	b1	H	h
149.0	49.0	0.8	139.0	23.5	143.0	45.0	19.5	2.0

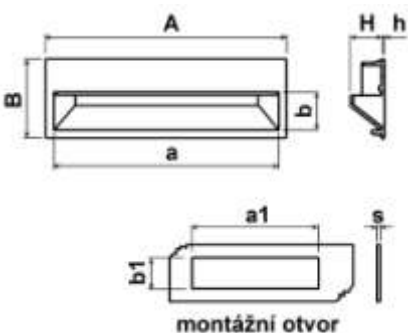

Držadla zapuštěná Typ: 291b-183-AxB(s)
Materiál: ABS; Barva: černá, bílá, šedá, stříbrná



A	B	s	a	b	a1	b1	H	h
93.0	36.0	0.8	83.0	21.5	87.5	30.7	16.5	2.5
93.0	36.0	1.0	83.0	21.5	87.5	30.7	16.5	2.5
93.0	36.0	1.2	83.0	21.5	87.5	30.7	16.5	2.5
93.0	36.0	1.5	83.0	21.5	87.5	30.7	16.5	2.5
93.0	36.0	2.0	83.0	21.5	87.5	30.7	16.5	2.5
93.0	36.0	2.5	83.0	21.5	87.5	30.7	16.5	2.5

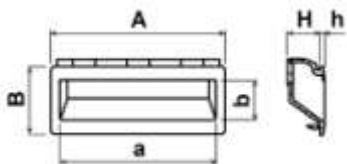

Držadla zapuštěná Typ: 291c-183-AxB(s)
Materiál: ABS; Barva: černá, bílá, šedá, stříbrná



A	B	s	a	b	a1	b1	H	h
138.0	36.0	0.8	128.5	23.5	132.0	30.7	17.5	3.0
138.0	36.0	1.0	128.5	23.5	132.0	30.7	17.5	3.0
138.0	36.0	1.2	128.5	23.5	132.0	30.7	17.5	3.0
138.0	36.0	1.5	128.5	23.5	132.0	30.7	17.5	3.0
138.0	36.0	2.0	128.5	23.5	132.0	30.7	17.5	3.0
138.0	36.0	2.5	128.5	23.5	132.0	30.7	17.5	3.0

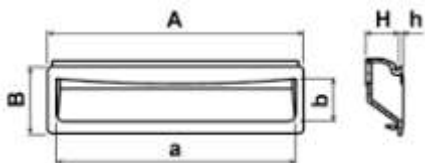

Držadla zapuštěná Typ: 291d-183-AxB(s)
Materiál: PS; Barva: černá, bílá, šedá, stříbrná



A	B	s	a	b	a1	b1	H	h
83.0	27.0	0.8	71.0	18.0	74.0	21.7	10.5	2.5
83.0	27.0	1.0	71.0	18.0	74.0	21.7	10.5	2.5
83.0	27.0	1.2	71.0	18.0	74.0	21.7	10.5	2.5
83.0	27.0	1.5	71.0	18.0	74.0	21.7	10.5	2.5

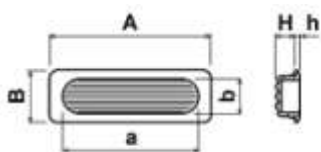

Držadla zapuštěná Typ: 291e-183-AxB(s)
Materiál: PS; Barva: černá, bílá, šedá, stříbrná



A	B	s	a	b	a1	b1	H	h
127.0	24.0	0.8	116.0	13.5	120.0	17.0	11.5	2.5
127.0	24.0	1.0	116.0	13.5	120.0	17.0	11.5	2.5
127.0	24.0	1.2	116.0	13.5	120.0	17.0	11.5	2.5
127.0	24.0	1.5	116.0	13.5	120.0	17.0	11.5	2.5

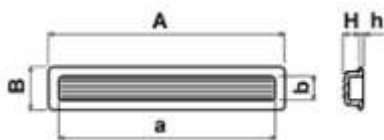

Držadla zapuštěná Typ: 291f-183-AxB(s)
Materiál: PS; Barva: černá, bílá, šedá, stříbrná



A	B	s	a	b	a1	b1	H	h
102.0	25.0	0.8	89.0	17.0	96.0	21.5	11.0	2.0
150.0	25.0	0.8	137.0	17.0	140.0	21.5	11.0	2.0

